

Aculas-AM-100X

Multi-channel Digital LLLT System



User's Guide



English

Front Panel	1
LCD Display	2
Rear Panel	3
Preparation Steps	4
Operation Steps	5
Using Aculas-AM	11
Tips and troubleshooting	12
Learning more, service and support	13
Safety and cleaning	14

Front Panel

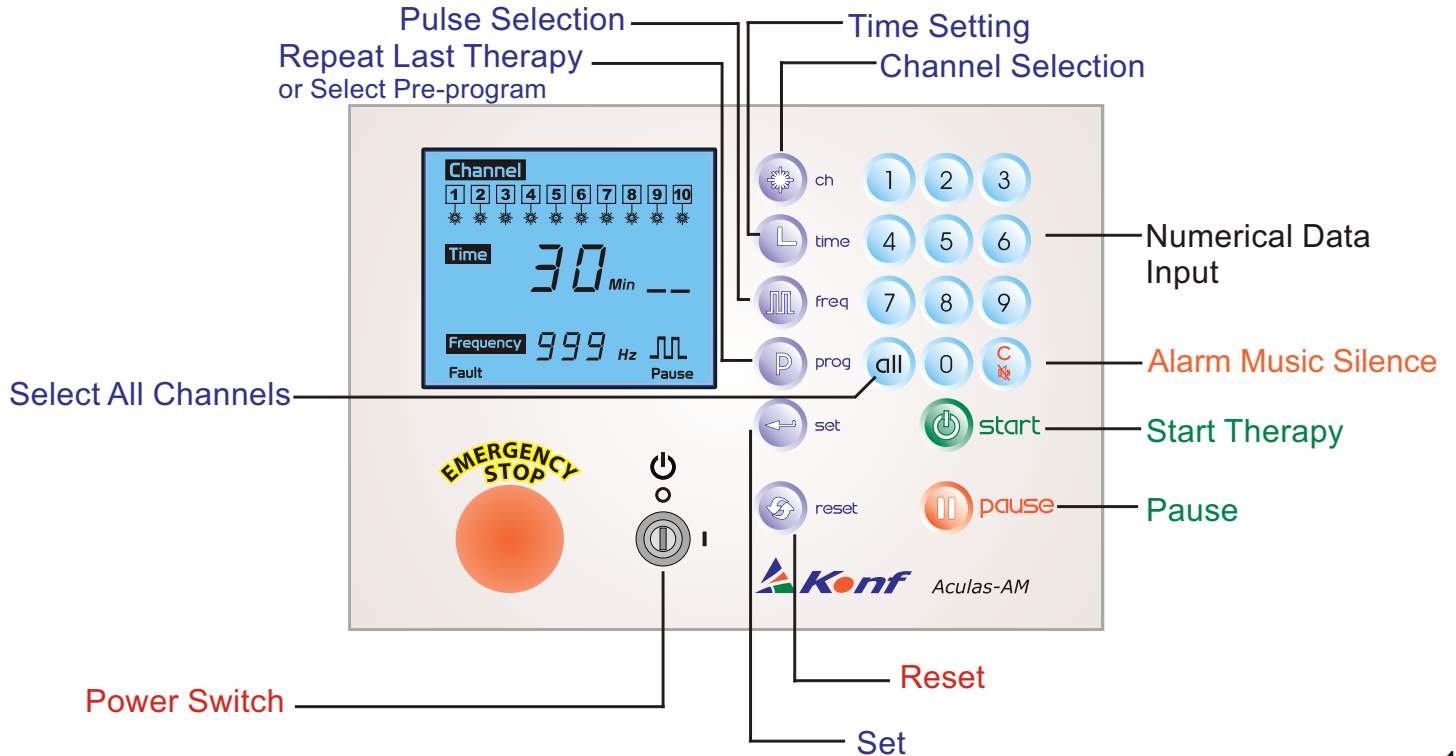

LCD Display

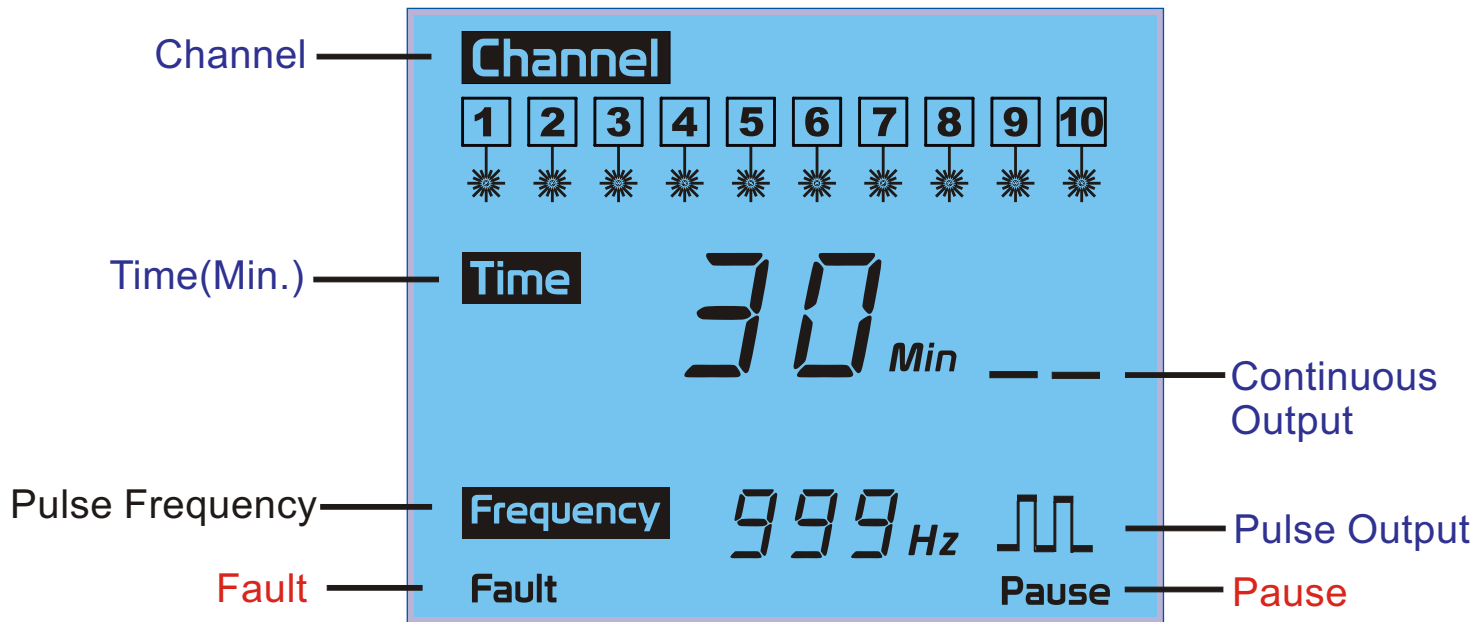

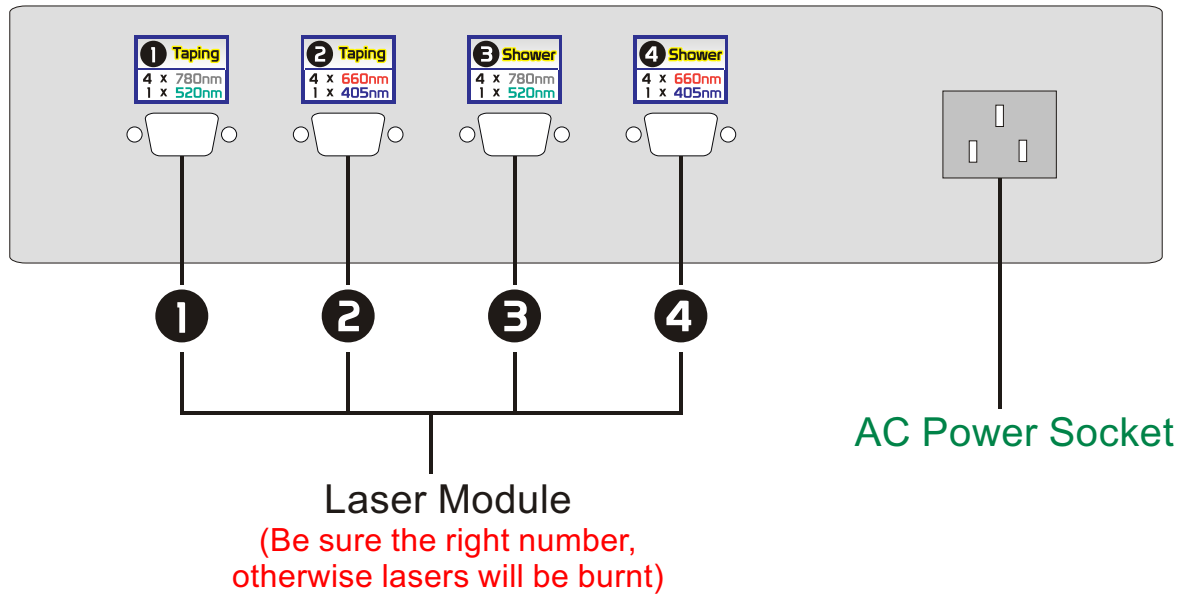

Rear Panel



Preparation Steps

Preparation			Illustration
STEP	ACTION	DESCRIPTION	
1	Connect Laser Modules	Connect laser modules to rear panel tightly	<p>The diagram shows a rear panel with four circular ports labeled 1, 2, 3, and 4. Port 1 is labeled '1 Taping 2 x 200mm 1 x 600mm'. Port 2 is labeled '2 Taping 2 x 200mm 1 x 405mm'. Port 3 is labeled '3 Shower 4 x 200mm 1 x 405mm'. Port 4 is labeled '4 Shower 4 x 200mm 1 x 405mm'. A bracket connects ports 1, 2, 3, and 4 to the text 'STEP-1'. To the right of these ports is a rectangular AC power inlet labeled 'STEP-2'.</p>
2	Connect Power	Connect AC power to rear panel	

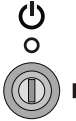

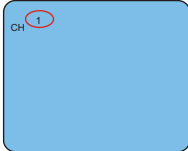
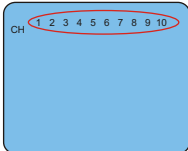
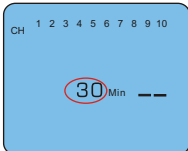

Operation Steps

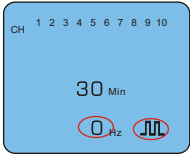
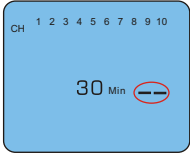
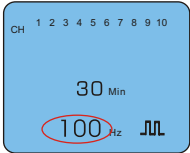
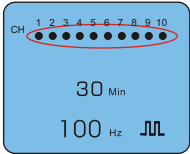
OPERATION			LCD DISPLAY	REMARKS
STEP	ACTION	KEY IN		
1	Power ON			Backlite ON
2-a	Select Channels Combination	<div style="display: flex; flex-direction: column; align-items: center; gap: 5px;"> <div style="display: flex; gap: 5px;"> Ch. 1 Set </div> <div style="display: flex; gap: 5px;"> 2 Set </div> <div style="display: flex; gap: 5px;"> 3 Set </div> </div>		Select Others: 2, Set; 3, Set; ----- <b style="color: red;">Note: Key-in Ch. Once only
2-b	Select All (10) Channels	<div style="display: flex; gap: 5px;"> Ch. ALL Set </div>		
3	Time Setting	<div style="display: flex; gap: 5px;"> Time 3 0 Set </div>		Time Setting: 1 ~ 60 Min.



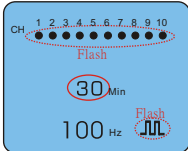

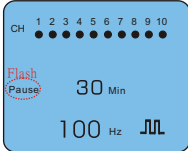

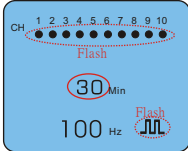
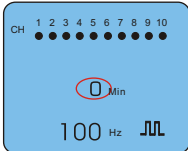
Operation Steps

OPERATION			LCD DISPLAY	REMARKS
STEP	ACTION	KEY IN		
4-a	Select Continuous Wave Output	No Need		
4-b	Select Pulse Output	Freq.		
5	Pulse Frequency Setting	9 9 9 Set		Setting Range: 1 ~ 999 Hz
6	Autos to Stand-by Mode after 3 Seconds	No Need		

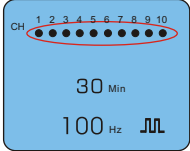
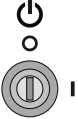

Operation Steps

OPERATION			LCD DISPLAY	REMARKS
STEP	ACTION	KEY IN		
7	Start Therapy			
⊙	Pause from Front Panel			Alert Music No.1
	Remote Pause			
	Alarm Music Silence			
⊙	Restart after Pause			
⊙	Time Count to Zero			Alert Music No.2 (Plays 15 Sec.)

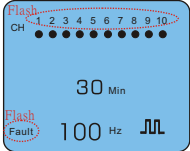
Operation Steps

OPERATION			LCD DISPLAY	REMARKS
STEP	ACTION	KEY IN		
⊙	Reset All Parameters			
⊙	Repeat the Last Therapy	 		
⊙	Power OFF			
★	Fault			Alert Music No.3

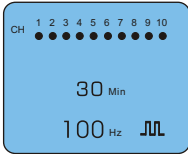
Program Setting

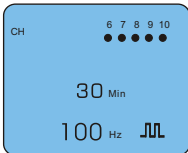
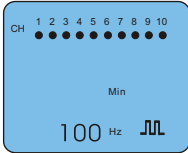
OPERATION			LCD DISPLAY	REMARKS
STEP	ACTION	KEY IN		Pre-programmed
◎	Execute Program-0	<div style="display: inline-block; border: 1px solid black; padding: 2px 5px; margin-right: 5px;">Prog.</div> <div style="display: inline-block; border: 1px solid black; background-color: black; color: white; padding: 2px 5px; margin-right: 5px;">Start</div>		CH.: Time: Hz:
◎	Execute Program-1	<div style="display: inline-block; border: 1px solid black; padding: 2px 5px; margin-right: 5px;">Prog.</div> <div style="display: inline-block; border: 1px solid black; background-color: black; color: white; padding: 2px 5px; margin-right: 5px;">1</div> <div style="display: inline-block; border: 1px solid black; background-color: black; color: white; padding: 2px 5px; margin-right: 5px;">Start</div>		CH.: Time: Hz:
◎	Execute Program-2	<div style="display: inline-block; border: 1px solid black; padding: 2px 5px; margin-right: 5px;">Prog.</div> <div style="display: inline-block; border: 1px solid black; background-color: black; color: white; padding: 2px 5px; margin-right: 5px;">2</div> <div style="display: inline-block; border: 1px solid black; background-color: black; color: white; padding: 2px 5px; margin-right: 5px;">Start</div>		CH.: Time: Hz:
★	Change Program Parameters	<div style="display: inline-block; border: 1px solid black; padding: 2px 5px; margin-right: 5px;">Prog.</div> <div style="display: inline-block; border: 1px solid black; padding: 2px 5px; margin-right: 5px;">Set</div> <div style="display: inline-block; border: 1px solid black; padding: 2px 5px; margin-right: 5px;">Prog.</div> <div style="display: inline-block; border: 1px solid black; background-color: black; color: white; padding: 2px 5px; margin-right: 5px;">1</div> <div style="display: inline-block; border: 1px solid black; padding: 2px 5px; margin-right: 5px;">Set</div> <div style="display: inline-block; border: 1px solid black; padding: 2px 5px; margin-right: 5px;">Prog.</div> <div style="display: inline-block; border: 1px solid black; background-color: black; color: white; padding: 2px 5px; margin-right: 5px;">2</div> <div style="display: inline-block; border: 1px solid black; padding: 2px 5px; margin-right: 5px;">Set</div>		

Program Setting

OPERATION			LCD DISPLAY	Programmed Parameters
STEP	ACTION	KEY IN		
◎	Change Program-1 Parameters	<div style="display: flex; flex-direction: column; align-items: center; gap: 10px;"> <div style="display: flex; align-items: center; gap: 5px;"> Prog. 1 Set </div> <div style="display: flex; align-items: center; gap: 5px;"> Ch. ALL Set </div> <div style="display: flex; align-items: center; gap: 5px;"> Time 3 0 Set </div> <div style="display: flex; align-items: center; gap: 5px;"> Freq. 1 0 Set </div> <div style="background-color: black; color: white; padding: 5px 15px; border-radius: 5px;">Start</div> <div style="display: flex; align-items: center; gap: 5px;"> </div> <p style="color: red; font-size: small;">After Start Switch Power OFF</p> </div>		CH.: 1 ~ 10 Time: 30 Hz: 10
★	Execute Program-1	<div style="display: flex; align-items: center; gap: 5px;"> Prog. 1 Start </div>		

Using Aculas-AM

Aculas-AM can be used for treatment of diseases and conditions, follow the recommended dosage and treatment time to get the best efficacy. You can also find new information about using Aculas-AM on the web www.konftec.com.

Laser module taping instruction

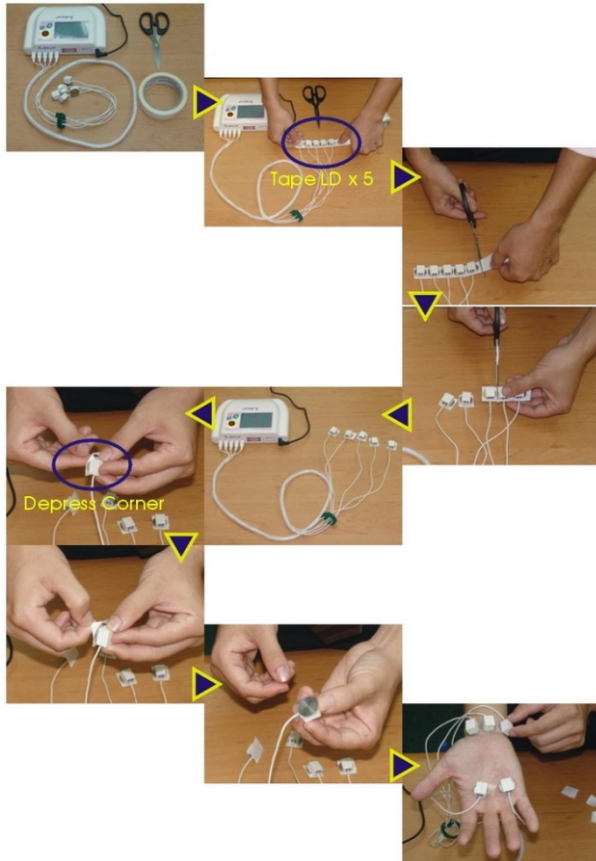
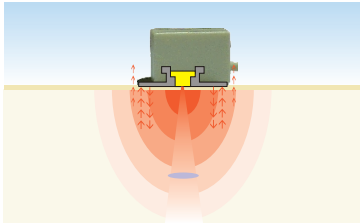

Laser shower instruction

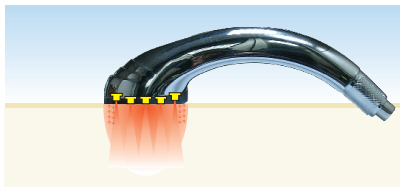

Tips and troubleshooting

Read on for advice about using and troubleshooting Aculas-AM.

My Aculas-AM won't turn on

- ☑ Make sure Aculas-AM's power switch is on.
- ☑ If that doesn't work, check the connection from Aculas-AM to the Aculas-AM power adapter and connect the adapter to a working electrical outlet.
If that doesn't work, contact your local sales office.

My Aculas-AM is flashing fault sign and is continuously playing music

- ☑ **Turn off the power switch** then reconnect the laser module.
- ☑ Repeat the operation steps:
 1. Turn on Aculas-AM's power switch.
 2. Press "**Prog**" (program) button to set the last therapy protocol.
Wait 3 seconds until the circles of CH. (channel) appear.
 3. Press "**Start**" button to begin the therapy.
- ☑ If that doesn't work, you can still temporarily use the working channels by deleting the faulty channel.
- ☑ Refer your **Operation Manual** for detailed operation steps.
- ☑ Contact your local sales office.

Learning more, service, and support

There is a wealth of information about using Aculus-AM on the web.

For the latest information on Aculus-AM service and support information go to

www.konftec.com.

Obtaining warranty service

If the product appears to be damaged or does not function properly, please follow the advice in this booklet, and the online resources. If the unit still does not function, go to

www.konftec.com for instructions on how to obtain warranty service.

Safety and cleaning

Read on to learn about using Aculas-AM safely and cleaning Aculas-AM.

Important safety instructions

When setting up and using your Aculas-AM, remember the following:

- ☑ Read user's guide carefully before you plug your Aculas-AM Power Adapter into a power outlet.
- ☑ Keep user's guide handy for reference by you and others.
- ☑ Follow all instructions and warnings dealing with your Aculas-AM.

Warning: Electrical equipment may be hazardous if misused.

- ☑ Operation of this device, must always be supervised by an adult. Do not allow children access to the interior of any electrical product and do not permit them to handle any cables.

Warning: Laser beam

- ☑ Avoid direct eye exposure to the laser beam.
- ☑ Because some Aculas-AM lasers emit invisible infrared light, the usage of laser shower or handheld unit in the area of the face and around the eyes must proceed with appropriate care and caution. Invisible infrared laser light penetrating the eye may cause serious harm after extended exposure. Therefore, the use of the optional laser safety goggles for the patient and clinician is advised.



Using the power adapter

- ☑ Use only the power adapter that came with your Aculas-AM. Adapters for other electronic devices may look similar, but they may damage your Aculas-AM.
- ☑ The only way to shut off power completely to your power adapter is to disconnect it from the power source.
- ☑ When connecting or disconnecting your power adapter, always hold the power adapter by its sides. Keep fingers away from the metal part of the plug.
- ☑ Before connecting the laser module cable to the power adapter, make sure there are no foreign objects inside the adapter's port.
- ☑ The power adapter for your Aculas-AM is a high-voltage component and should not be opened for any reason, even when the Aculas-AM is off. If the power adapter needs service, see “Learning more, service and support.”

About operating and storage temperatures

- ☑ Operate your Aculas-AM in a place where the temperature is always between 0 and 40° C (32 to 105° F).
- ☑ Store your Aculas-AM in a place where the temperature is always between -20 and 85° C (-4 to 185° F).
- ☑ When you are using your Aculas-AM, it is normal for the bottom of the power supply case to get warm.

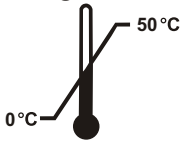

Avoid wet locations

Warning



- To reduce the chance of shock or injury, do not use your Aculas-AM in or near water or wet locations.
- Keep your Aculas-AM and power adapter away from sources of liquids, such as drinks, wash basins, bathtubs, shower stalls, and so on.
- Protect your Aculas-AM and the power adapter from direct sunlight and rain or other moisture.
- Take care not to spill any food or liquid on Aculas-AM or its power adapter. If you do, unplug Aculas-AM before cleaning up the spill.
- Depending on what you spilled and how much of it got into your equipment, you may have to send your equipment to Konftec for service. See “Learning more, service, and support.”



Do not make repairs yourself

Warning

- Do not attempt to open your Aculas-AM or power adapter, disassemble it. You run the risk of electric shock and voiding the limited warranty.
- No user-serviceable parts are inside.
For service, see “Learning more, service, and support.”

Cleaning

Follow these general rules when cleaning the outside of your Aculas-AM and its components:

- Make sure your Aculas-AM is unplugged.
- Use a damp, soft, lint-free cloth. Avoid getting moisture in openings.
- Don't use aerosol sprays, solvents or abrasives.

About handling

- Your Aculas-AM may be damaged by improper storage or handling.
- Be careful not to drop your Aculas-AM when treating or transporting the device.



Konftec Corporation

12F-7, No.77, Sintai 5th Rd., Sec. 1,
Sijhih District, New Taipei City 221
Taiwan

www.konftec.com

© 2013 Konftec Corporation. All rights reserved.
Konf, the Konf logo, Aculas, and Aculas-AM
are trademarks of Konftec Corporation,
registered in Taiwan and
other countries.

UAMMX_30601E

