

# ***emLas-900***

Digital LLLT Irradiation System



# **User's Guide Veterinary**



English

Getting started	1
Using <i>emLas-900</i>	3
Tips and troubleshooting	4
Learning more, service and support	5
Safety and cleaning	6
Therapy Protocol	9

# Getting started

Read on to find out how to get started low level laser therapy (LLLT) with *emLas*.

---

## 1 Connect DC power supply







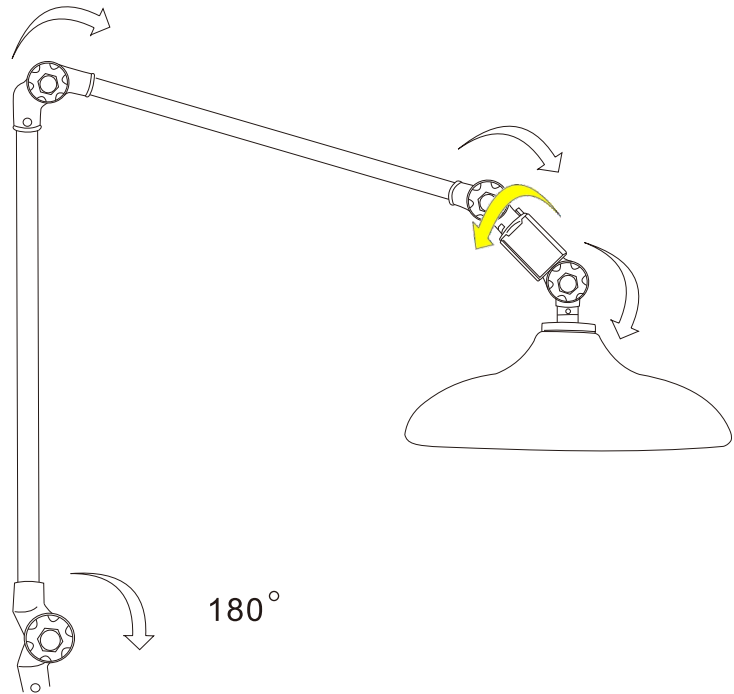



Connect power plug to the controller.

## 2 Connect AC power supply

Connect power plug to city power.



### 3 Operation steps and LED display

Operation			LED Display
STEP	ACTION	PUSH	
1	Power ON		Last treatment time 
2	Time Setting	  Decrease    Increase	
3	Start		 Flash
Opt.	Emergency Stop	 > 5 Seconds	
		or  + 	



## Using *emLas*

*emLas* is used as the controller, combined with the laser accessories for the treatment of diseases and conditions, follow the recommended dosage and treatment time to get the best efficacy. You can also find new information about using *emLas* on the web [www.konftec.com](http://www.konftec.com).

<b>Specifications</b>					
Operation Environment	0 ~ 50 °C (32 ~ 122 °F); 10 ~ 95%RH (Non-condensing)				
Power Input Voltage	90V AC ~ 264V AC				
Power Input Frequency	47Hz ~ 63Hz				
Power Input Current	Max. 1A (115V AC), 0.5A (230V AC)				
<b>Model No. Selection</b>					
Model No.	Laser Module				Total Output Power
	Wavelength	660 nm	780 nm	808 nm	
	Power	100 ± 5 mW	100 ± 5 mW	100 ± 5 mW	
<i>emLas-900B</i>	20			2,000 mW	
<i>emLas-900C</i>	1	19		2,000 mW	
<i>emLas-900D</i>	1		19	2,000 mW	

## Tips and troubleshooting

Read on for advice about using and troubleshooting *emLas*.

---

### My *emLas* won't turn on



- ☑ Make sure the connectors are in the right positions.
- ☑ If that doesn't work, check the connection from *emLas* to the power adapter and connect the adapter to a working electrical outlet. The LED indication should be ON.
- ☑ If that doesn't work, contact your local sales office.

## **Learning more, service, and support**

There is a wealth of information about using emLas on the web.

For the latest information on emLas service and support information go to

[www.konftec.com](http://www.konftec.com).

---

### **Obtaining warranty service**

If the product appears to be damaged or does not function properly, please follow the advice in this booklet, and the online resources. If the unit still does not function, go to

[www.konftec.com](http://www.konftec.com) for instructions on how to obtain warranty service.

# Safety and cleaning

Read on to learn about using *emLas* safely and cleaning *emLas*.

---

## Important safety instructions

When setting up and using your *emLas*, remember the following:

- ☑ Read user's guide carefully before you plug your *emLas* Power Adapter into a power outlet.
- ☑ Keep user's guide handy for reference by you and others.
- ☑ Follow all instructions and warnings dealing with your *emLas*.

**Warning:** Electrical equipment may be hazardous if misused.

- ☑ Operation of this device, must always be supervised by an adult. Do not allow children access to the interior of any electrical product and do not permit them to handle any cables.

## Warning: Laser beam

- ☑ Avoid direct eye exposure to the laser beam.
- ☑ Because some *emLas* lasers emit invisible infrared light, the usage of laser part in the area of the face and around the eyes must proceed with appropriate care and caution.
- ☑ Invisible infrared laser light penetrating the eye may cause serious harm after extended exposure. Therefore, the use of the optional laser safety goggles is advised.





## Using the power adapter

- ✓ Use only the power adapter that came with your *emLas*. Adapters for other electronic devices may look similar, but they may damage your *emLas*.
- ✓ The only way to shut off power completely to your power adapter is to disconnect it from the power source.
- ✓ When connecting or disconnecting your power adapter, always hold the power adapter by its sides. Keep fingers away from the metal part of the plug.
- ✓ Before connecting your *emLas* to the power adapter, make sure there are no foreign objects inside the adapter's port.
- ✓ The power adapter for your *emLas* is a high-voltage component and should not be opened for any reason, even when the *emLas* is off. If the power adapter needs service, see “Learning more, service, and support.”

## About operating and storage temperatures

- ✓ Operate your *emLas* in a place where the temperature is always between 0 and 50° C (32 to 122° F).
- ✓ Store your *emLas* in a place where the temperature is always between -20 and 85° C (-4 to 185° F).
- ✓ When you are using your *emLas*, it is normal for the bottom of the power adaptor case to get warm.

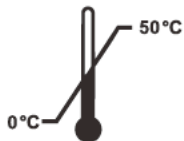

## Avoid wet locations

**Warning** To reduce the chance of shock or injury, do not use your *emLas* in or near water or wet locations.



- ☑ Keep your *emLas* and power adapter away from sources of liquids, such as drinks, wash basins, bathtubs, shower stalls, and so on.
- ☑ Protect your *emLas* and the power adapter from direct sunlight and rain or other moisture.
- ☑ Take care not to spill any food or liquid on *emLas* or its power adapter. If you do, unplug *emLas* before cleaning up the spill.
- ☑ Depending on what you spilled and how much of it got into your equipment, you may have to send your equipment to Konftec for service. See “Learning more, service, and support.”

## Do not make repairs yourself

**Warning** Do not attempt to open your *emLas* or power adapter, disassemble it. You run the risk of electric shock and voiding the limited warranty. No user-serviceable parts are inside. For service, see “Learning more, service, and support.”



## Cleaning

Follow these general rules when cleaning the outside of your *emLas* and its components:

- ☑ Make sure your power adaptor of *emLas* is unplugged.
- ☑ Use a damp, soft, lint-free cloth. Avoid getting moisture in openings.
- ☑ Don't use aerosol sprays, solvents or abrasives.

## About handling

- ☑ Your *emLas* may be damaged by improper storage or handling.
- ☑ Be careful not to drop you *emLas* when treating or transporting the device.

# Therapy Protocol

## emLas-900 Laser Therapy Protocol - Small Animals

### Terminology:

- 3+2+1 = Three treatments the first week, two the second, and one the third
- "Acute" generally refers to an orthopedic condition that is less than 10 days old, or a medical condition 1~2 days old.
- "Chronic" generally refers to an orthopedic condition that is more than 10 days old or a medical condition more than 2 days old.
- Maintenance = 1 treatment every 2~4 weeks
- NR = Not Recommend

Indication	Frequency	Dose (J/cm <sup>2</sup> )	Therapy Time (min.)	Notes
			emLas-900B, C, D	
			Irradiation Area (cm <sup>2</sup> )	
			Power (mW)	
			Power Density	
Abscess Incision	1/day for 4~5 days	4	10	

Indication	Frequency	Dose (J/cm <sup>2</sup> )	Therapy Time (min.)	Notes
			emLas-900B, C, D	
Drainage and Flush Abscess with Cellulitis, Incision, Drainage, and Flush	1/day for 5~6 days	4	10	
Allergic Pododermatitis	2~3/week or 3+2+1	3	8	
Amputation	Immediate	4	10	Post Surg 1x, Acute pain 2-3 days
Anal Sacculitis / Acute	2~3/week or 3+2+1	4	10	
Anal Sacculitis / Chronic	2~3/week or 3+2+1	3	8	
Anterior Cruciate Ligament Tear - Chronic	2/week	3	8	
Anterior Cruciate Ligament Tear, Full - Acute	3+2+1	4	10	
Anterior Cruciate Ligament Tear, Partial - Acute	3/week	4	10	1~3/week for 3 weeks. Exercise restriction
Arthritic Conditions	2~3/week or 3+2+1	4	10	Maintenance

Indication	Frequency	Dose (J/cm <sup>2</sup> )	Therapy Time (min.)	Notes
			emLas-900B, C, D	
Aural Hematoma(Post Surgery)	1/day	3	8	Acute inflammation 1x Immobilize ear, treat cause
Burns	1/day for 3~5 days then 2~3/week until healed	4	10	
Cauda Equina Syndrome	3+2+1	5	13	Maintenance
Cystitis/Interstitial	3+2+1	4	10	3~4 weeks
Cystitis/Urethritis/Feline Lower Urinary Tract Disease	3+2+1	4	10	Maintenance
Cystotomy	During surgery	4	10	Maintenance as needed
Decubital Ulcers	1/day for 3~5 days then 2~3/week until healed	3	8	
Degenerative Disc Disease	1/day for 3~5 days then 2~3/week	5	13	
Degenerative Joint Disease	2~3/week or 3+2+1	5	13	Maintenance
Degloving Wounds	1/day for 3~5 days then 2~3/week until healed	4	10	3~4 weeks

Indication	Frequency	Dose (J/cm <sup>2</sup> )	Therapy Time (min.)	Notes
			emLas-900B, C, D	
Dewclaw Removal	Immediately post-op	4	10	
Dorsolateral Hemilaminectomy	Immediately post-op, then 2~3x more	4	10	
Edema	1-2x	5	13	
Enterotomy	During surgery 2~3/week or 3+2+1	4	10	
Feline Acne	Post surgical 1x	3	8	Be careful of thyroid
Feline Declaw	Immediately post-op	3	8	Also next day if in hospital
Feline Tail Pull injuries	2~3/week or 3+2+1	3	8	
Femoral Head Ostectomy	Immediately post-op	3	8	Also next day if in hospital
FLUTD(Feline Lower Urinary Tract Disease) - Blocked Urethra	1x to relieve blockage	3	8	3+2+1 for cystitis if needed(will not break up crystals but small ones may pass)

Indication	Frequency	Dose (J/cm <sup>2</sup> )	Therapy Time (min.)	Notes
			emLas-900B, C, D	
Fractures - After Surgery	2~3/week or 3+2+1	4	10	
Gingivitis	2~3x, based on severity	3	8	Determine acute or chronic
Hernia Repair	2~3/week or 3+2+1	5	13	(Not a substitute for cleaning)
Hip Dysplasia	2~3/week or 3+2+1	5	13	Post-op
Hot Spots	3+2+1	5	13	Every 3~4 weeks as needed
Inflammatory Bowel Disease	2~3/week or 3+2+1	5	13	Treat with other modalities, pharmaceuticals
Insect Bite/Snake Bite	1x, may need 3+2+1	3	8	1~3x, depending on bite severity
Intervertebral Disc Disease	2~3/week or 3+2+1	8	21	May need follow up treatment
Intra-abdominal	1x during Surgery	5	13	

Indication	Frequency	Dose (J/cm <sup>2</sup> )	Therapy Time (min.)	Notes
			emLas-900B, C, D	
Joint Injury - Acute	Once - up to 6x	8	21	Frequently improves after 1 treatment
Lesions	2~3/week or 3+2+1	4	10	
Lick Granulomas	Daily or 2~3/week or 3+2+1	3	8	Depends on size
Luxating Patella	3+2+1	5	13	Treat after surgery, not as a substitute
Musculoskeletal Pain	1~3x, once daily	5	13	
Myofascial Pain	2~3/week or 3+2+1	5	13	
Nerve Regeneration	2~3/week or 3+2+1	5	13	
Neuropathies	2~3/week or 3+2+1	5	13	
Orchiectomy Canine and Feline	Immediately post-op 1x	4	10	



Indication	Frequency	Dose (J/cm <sup>2</sup> )	Therapy Time (min.)	Notes
			emLas-900B, C, D	
Otitis - Acute	2~3/week or 3+2+1	5	13	Then every 3~4 weeks, if chronic
Otitis External - w/infection	2~3/week or 3+2+1	5	13	
Otitis External - w/o Infection	2~3/week or 3+2+1	5	13	
Otitis Media / External - Chronic	2~3/week	3	8	3+2+1, then once every 3~4 weeks
Ovariohysterectomy Canine and Feline	Immediately post-op 1x	5	13	
Perianal Fistulas	1/day for 3~5 days then 2~3/week	3	8	Use with pharmaceuticals
Periodontal Diseases	2~3/week or 3+2+1	3	NR	Determine acute or chronic
Staph Infections - Local	2/week	3	8	
Sterile Pyogranulomatous Syndrome pyogranuloma / granuloma	Daily for 2~3x, then 2~3/week	3	8	
Stifle Surgery - TPLO/TTA	3+2+1	4	10	

Indication	Frequency	Dose (J/cm <sup>2</sup> )	Therapy Time (min.)	Notes
			emLas-900B, C, D	
Stomatitis	Daily (Depends how chronic)	3	NR	Can also use 3+2+1 (6~12 treatments, then maintenance)
Tendon & Ligament Injury	2~3/week or 3+2+1	5	13	
Tightrope/Extracapsular	3+2+1	5	13	Wait 6 weeks for scar to form, then Chronic inflammation
Traumatic & Overuse Injuries	2~3/week or 3+2+1	5	13	
Vasculitis - Non-infectious	2~3/week or 3+2+1	5	13	Be careful of possible thrombosis
Wounds	3~5/day	5	13	Decrease treatments as healing progresses



**Konftec Corporation**

12F-7, No.77, Sintai 5th Rd., Sec. 1,  
Sijhih District, New Taipei City 221  
Taiwan

[www.konftec.com](http://www.konftec.com)

© 2015 Konftec Corporation. All rights reserved.

Konf, the Konf logo and *emLas*  
are trademarks of Konftec Corporation,  
registered in Taiwan and  
other countries.

UEM900\_Vet\_50702E

